

Leica DISTO™ with Bluetooth Smart usage on iOS

V 1.0

December 2013

- when it has to be **right**

Leica
Geosystems

Content

- Leica DISTO™ devices
- Bluetooth compatibility
- Leica DISTO™ Bluetooth Smart
- Leica DISTO™ sketch for iOS
- Keyboard Mode iOS

The Leica DISTO™ devices with Bluetooth®



Leica DISTO™ D3a BT (D330i)
Bluetooth® 2.1

→ Requires **SPP** support



Leica DISTO™ D8
Bluetooth® 2.1

→ Requires **SPP** support



Leica DISTO™ D510
Bluetooth® Smart

→ Requires **Bluetooth® 4.0**



















Leica DISTO™ D810 touch
Bluetooth® Smart

→ Requires **Bluetooth® 4.0**



- when it has to be **right** 

Overview DISTO™ compatibility

	Availability	Windows 7 	Windows 8 	Windows Mobile 6.5	Android 	iOS 
Leica DISTO™ sketch *)		-	-	-	-	
Leica DISTO™ sketch *)		-	-	-	 Android 4.3	-
Leica DISTO™ transfer **)		-	-	-	 Android 4.3	-
Leica DISTO™ transfer PPC ***)	www.disto.com 	-	-		-	-
Leica DISTO™ transfer PC ***)	www.disto.com 		 Windows 8.1 ****)	-	-	-
Keyboard Mode ***)	No installation required	-		-	-	

*) Draw sketches and export these as pdf file or the measurements via csv file

***) Integrated Excel application to send values to a spread sheet. Also measurements are transferred into the clipboard to be pasted at any position in an application

****) DISTO™ connects as a keyboard and sends data right to cursor position in any application or software

*****) In development, planned for January 2014

Prolog

This presentation should provide further advice on how to use the Leica DISTO™ with Bluetooth® Smart. Also the corresponding Apps for iOS are described in this document.

Leica DISTO™ Bluetooth Smart



Getting started

- when it has to be **right** *Leica*
Geosystems

General

Bluetooth® Smart

- Bluetooth® Smart is compatible with Bluetooth® 4.0 or Bluetooth® Smart Ready devices
- Bluetooth® Smart has very low power consumption why it is by default switched on

Leica DISTO™ D510

Bluetooth® Smart

- The Bluetooth® can be switched off in the Settings of the Leica DISTO™ D510
- The Leica DISTO™ D510 only supports the connection to iOS or Android 4.3 Apps



Press '=' to switch on or off

Leica DISTO™ D810 touch Bluetooth® Smart

- The Bluetooth® can be switched off in the Settings of the Leica DISTO™ D810 touch



Leica DISTO™ D810 touch Bluetooth® Smart

- The Leica DISTO™ D810 touch provides 3 different modes for use with Bluetooth®

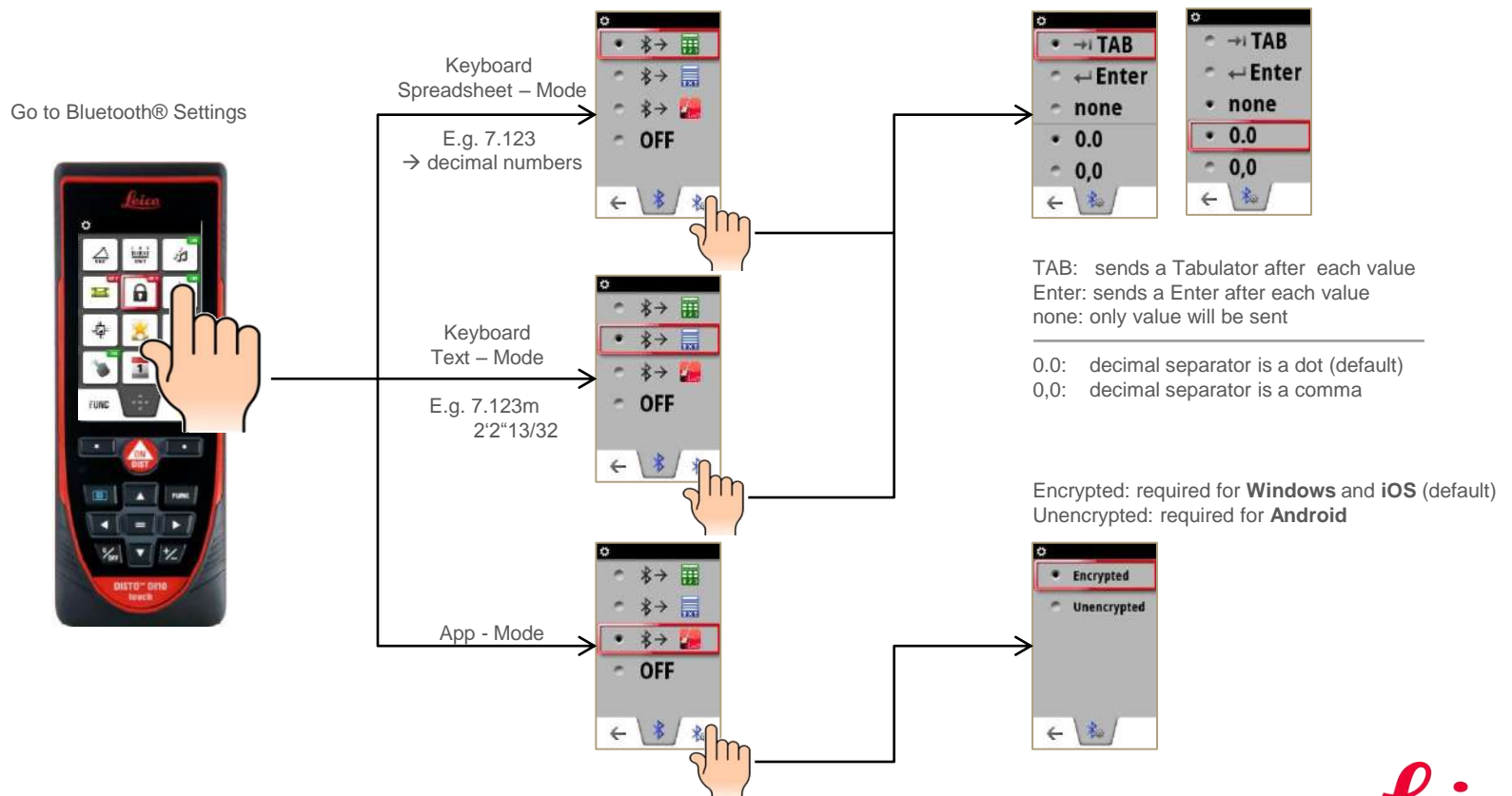



Leica DISTO™ sketch

iOS

Getting started

- when it has to be **right**

Leica
Geosystems

Leica DISTO™ sketch for iOS

Start App

- When using with Leica DISTO™ D810 touch we are recommending to use the App mode for Bluetooth®



Tutorial

- when it has to be right

Leica
Geosystems



This App only works with Leica DISTO™ D510 and D810 touch

Leica DISTO™ sketch for iOS

Start App – Connect Bluetooth®

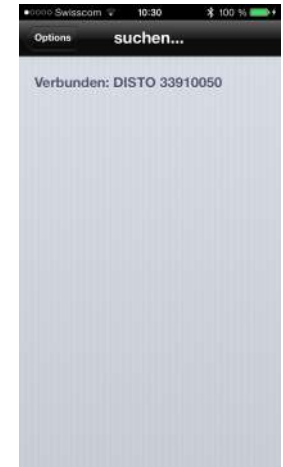
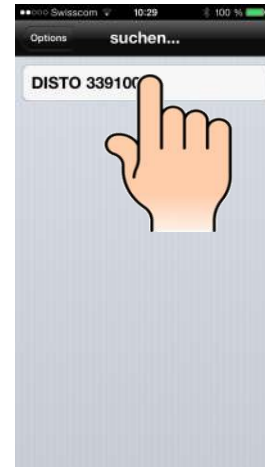
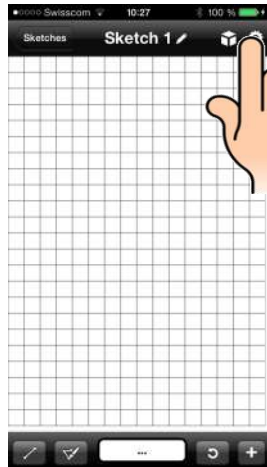
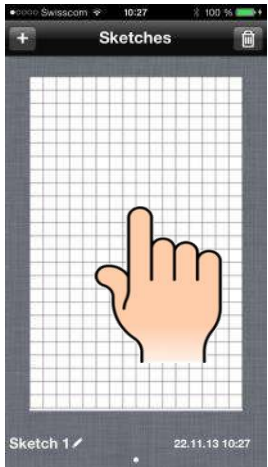

Message only appears for
Leica DISTO™ D810 touch

Leica DISTO™ sketch for iOS

Sketch layout Overview

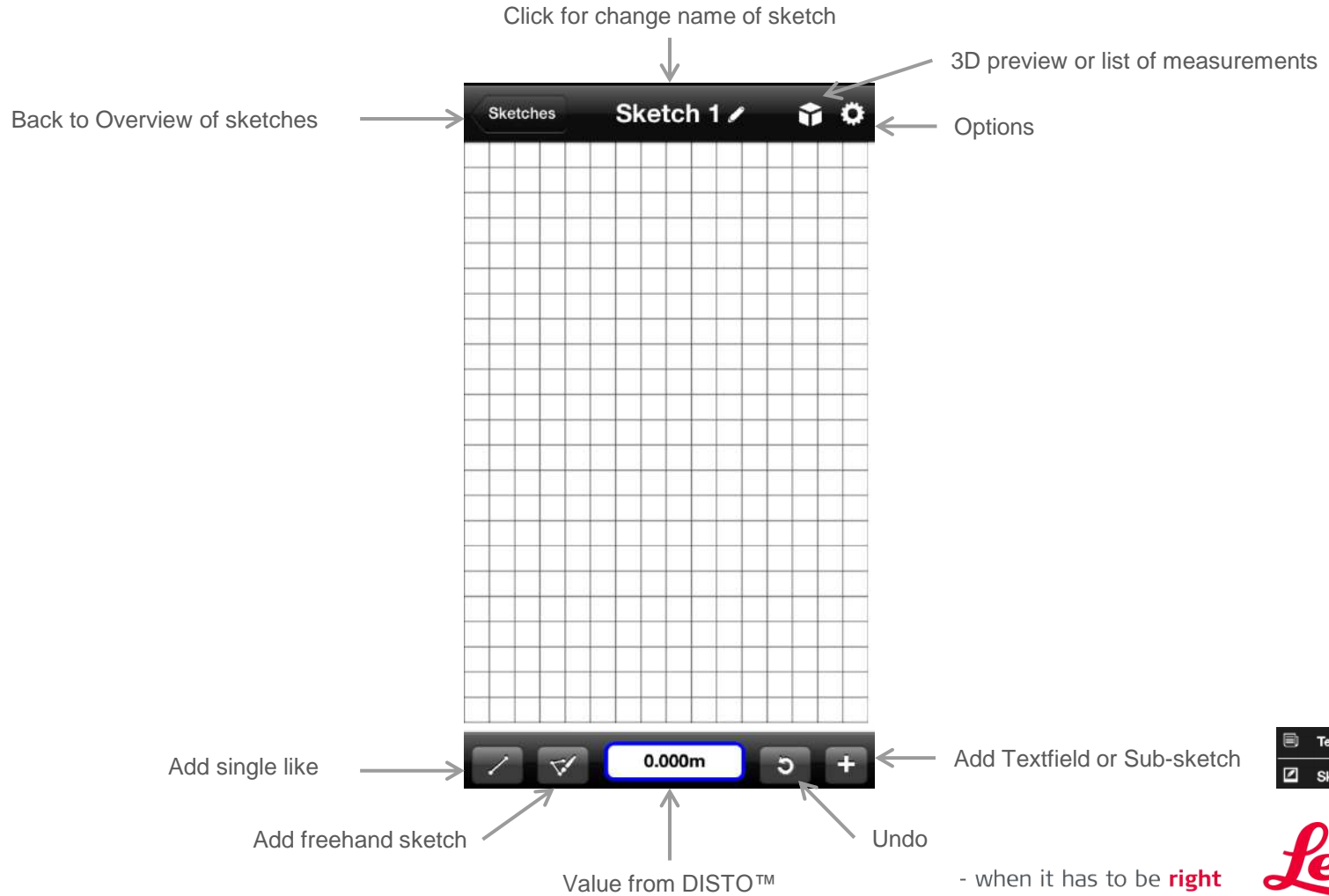

Value	Angle	Level
7.479m	0.00°	Line 1
7.509m	0.00°	Line 2
3.807m	0.00°	Line 3
4.077m	0.00°	Line 4
3.589m	0.00°	Line 5
3.007m	0.00°	Line 6

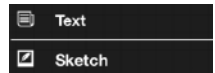

Leica DISTO™ sketch for iOS

Options Overview

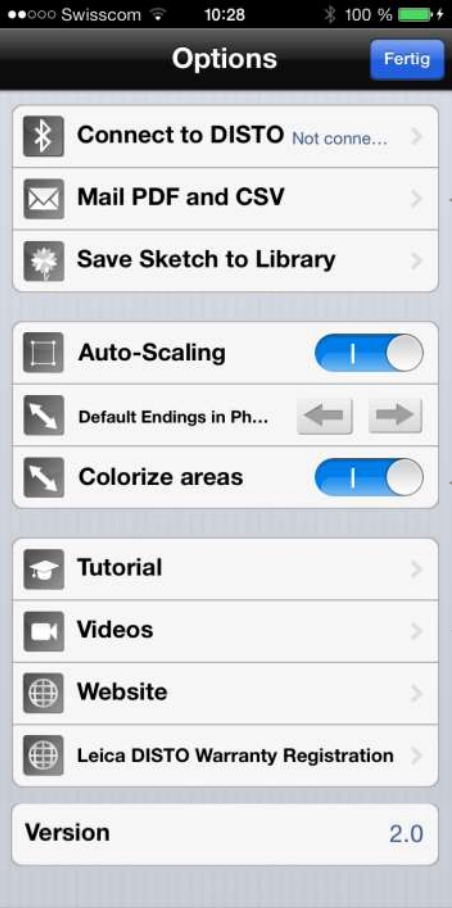

Establish Bluetooth® connection

Save drawing or photo and file with list of measurements in photo library

Set type of endings for dimension lines in photos

Start Tutorial

Visit Leica DISTO™ webpage

Software version of App

Send pdf file with drawing or photo and csv file with list of measurements via email

Scales drawing according measurements

Enable coloring of closed areas

See Video on YouTube

Go to DISTO™ registration for 3rd year warranty

- when it has to be right



Leica DISTO™ sketch for iOS

Create new sketch

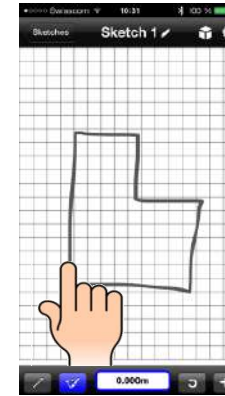
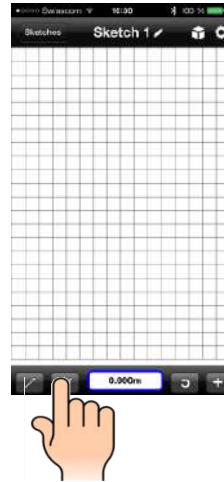
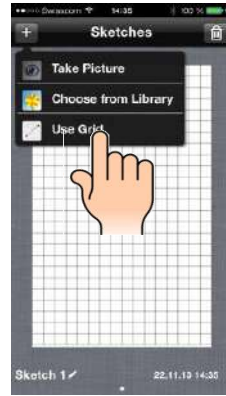
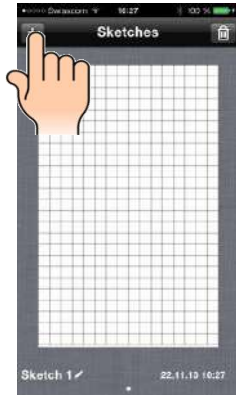

Draw freehand sketch

Magnification of point

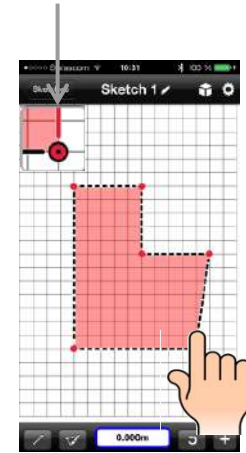

Hold finger on corner and move to rectangular shape

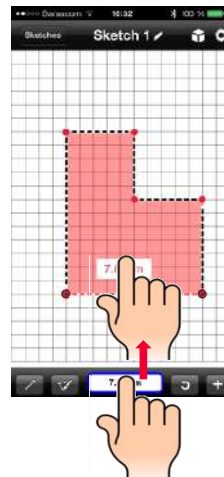
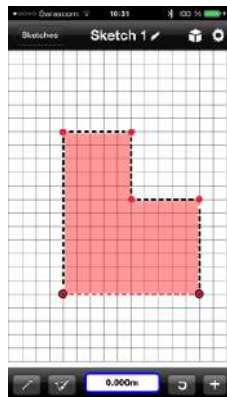

Move Value to line

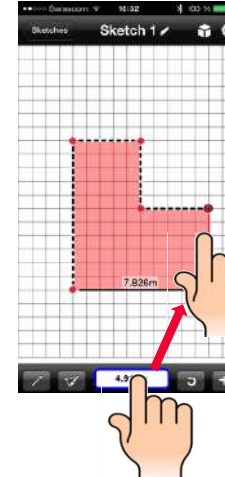

Move Value to line

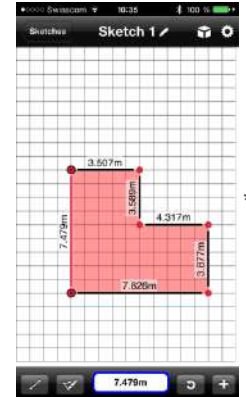

*)

Please Note

*) Auto-scale only works on rectangular sketches and it will not change any room angle on the sketch from 90°

Leica DISTO™ sketch for iOS

Create new sketch with photo

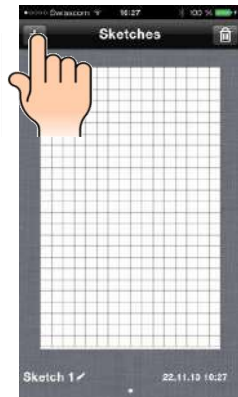

Leica DISTO™ sketch for iOS

Download and use of pdf-documents

Send Email with pdf document and open it on iPhone or iPad

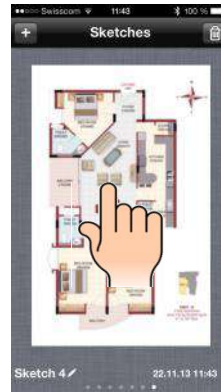
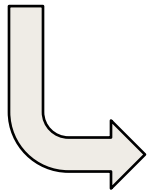

Leica DISTO™ sketch for iOS

Adding Sub-sketches and Text to sketches

From 2D Floorplan

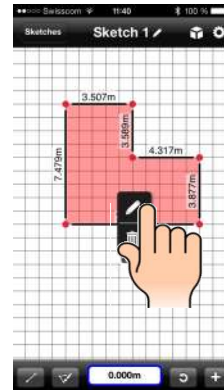
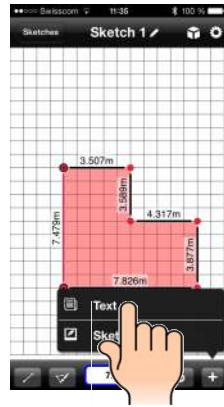
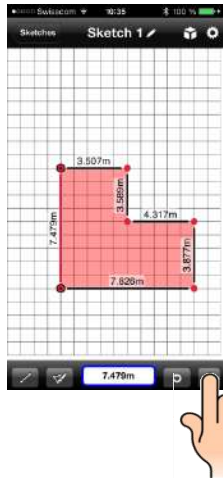

Click on pen to enter Text

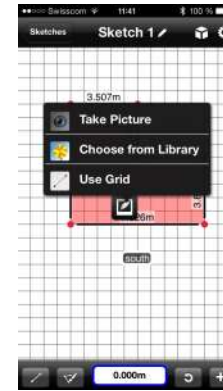
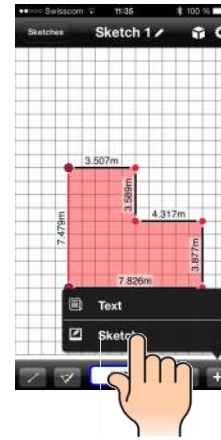

Choose picture, grid or library

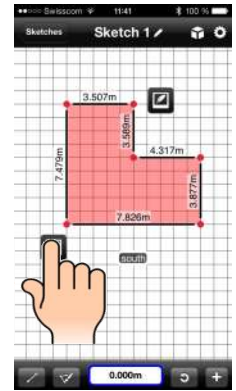

Click and hold for moving icon

From 3D Preview

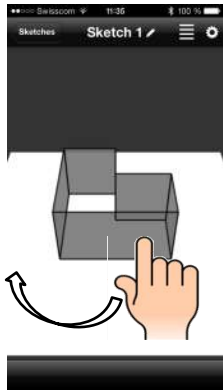

Wipe for rotating

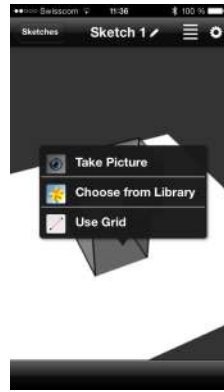

Choose picture, grid or library

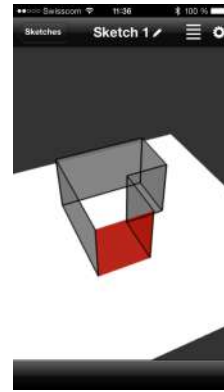

Red wall indicates sub-sketch

- when it has to be **right**



To edit a Text field or sub-sketch in 2D Floorplan click on the Icon or text and then click on the pen symbol

Leica DISTO™ sketch for iOS

Good to know

- If you want to unpair device to prevent automatic detection either switch off Bluetooth® at DISTO™ or press „Forget device“ in the settings of the iOS device

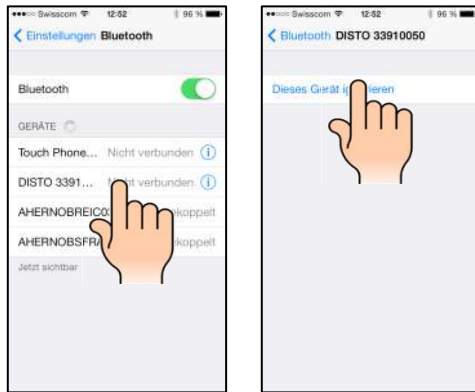

Please Note

When a Leica DISTO™ D810 touch is already paired with one iOS device it cannot be paired with a second device at the same time, it needs to be unpaired first!

Leica DISTO™ sketch for iOS

Good to know

- Auto-scale only works on rectangular sketches and it will not change any room angle on the sketch from being 90°
- The Leica DISTO™ device only sends the currently measured value. To send a result from the main line of the DISTO™ press the „=„ key
- You can also send any measurement value to the Text input field

Leica DISTO™ sketch for iOS

Good to know

- If you like to transfer distance measurement values including the inclination you need to switch on the Level option in the Setting of your Leica DISTO™ device.



- You can also transfer an area, volume or a slope by sending the „=„ key of your Leica DISTO™ device

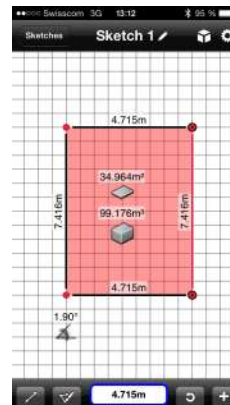

- when it has to be **right**



Keyboard Mode

iOS

Getting started

- when it has to be **right**

Leica
Geosystems

Keyboard Mode with iOS

How to start

- This mode is only supported by the **Leica DISTO™ D810 touch**
- You can use either the iOS Bluetooth® manager to pair the devices or the Leica DISTO™ sketch App. Once the iOS device and the Leica DISTO™ are paired they will immediately connect if both are switched on.
- The Leica DISTO™ will be considered as a keyboard. So by sending a measurement the iOS device believes you are writing the value on a keyboard.
- You need to either set the DISTO™ D810 touch to following modes (see also page 10 of this presentation)
 - Spreadsheet mode:
Use for sending decimal values without unit for further calculation
 - Text mode:
Use for sending values on the device display incl. unit for documentation



- when it has to be **right**

Keyboard Mode with iOS

How to send data and navigate in a Program

- After the devices are connected the favorite keys will change for sending measurement values or navigation

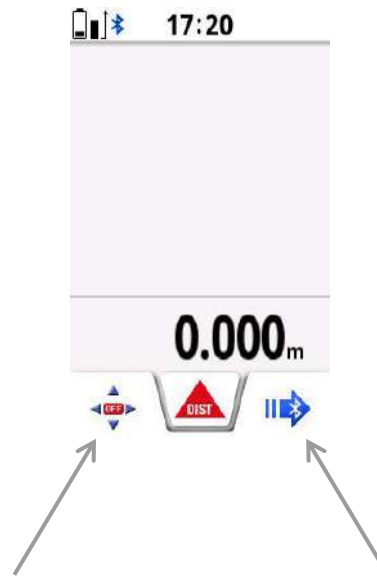

If switched on the Arrow keys on the DISTO™ can be used for navigation on e.g. Excel

Sends the actual value in the main-line of the DISTO™ to the current cursor position of any App

Keyboard Mode with iOS

Good to know

- If you want to unpair device to prevent automatic detection either switch off Bluetooth® at DISTO™ or press „Forget device“ in the settings of the iOS device

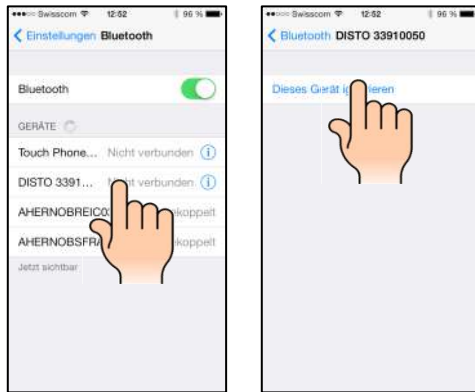

When a Leica DISTO™ D810 touch is already paired with one iOS or Windows 8 device it cannot be paired with a second device at the same time, it needs to be unpaired first!